







MS911

				
<p>/AW2 2 fils - wires -adrig - draden</p> <p>/CW2 3 fils - wires -adrig - draden</p> <p>/ALW2 4 fils - wires -adrig - draden</p> <p>/CLW2 5 fils - wires -adrig - draden</p>	<p>12 x 87 x 38</p>	<p>NO / SCHLIEßER</p>	<p>200V DC / 500 mA</p>	<p>0,3 kg</p>
<p>INVERSEUR/CHANGEOVER WECHSLER/WISSELCONTACT</p>		<p>100V DC / 250 mA</p>		
<p>NO / SCHLIEßER + AUTOPROTECTION / LOOP /SELBSTÜBERWACHUNG /AUTO-BESCHERMING</p>		<p>200V DC / 500 mA</p>		
<p>INVERSEUR/CHANGEOVER WECHSLER/WISSELCONTACT + AUTOPROTECTION / LOOP /SELBSTÜBERWACHUNG /AUTO-BESCHERMING</p>		<p>100V DC / 250 mA</p>		
<p>DISTANCE DE REACTION SWITCHING DISTANCE ANSPRECHABSTAND ANTWOORD AFSTAND</p> <p>50 mm</p>			<p>LONGUEUR CABLE CABLE LENGTH KABELLÄNGE KABEL LENGTE</p> <p>2 m</p>	
<p> 68</p>		<p> -20 + 70° C</p>		

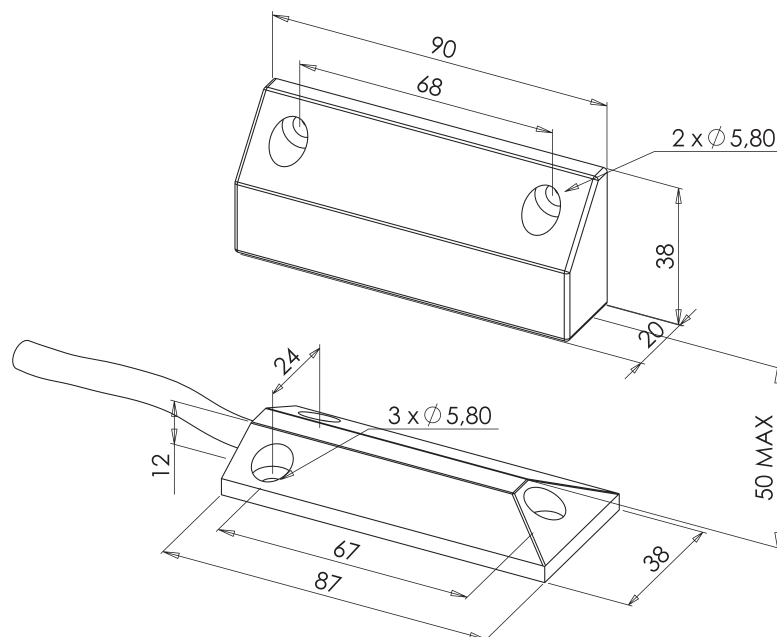

MS911/AW2

Contact 2 fils / 2 wires / 2-adrig / 2 draden

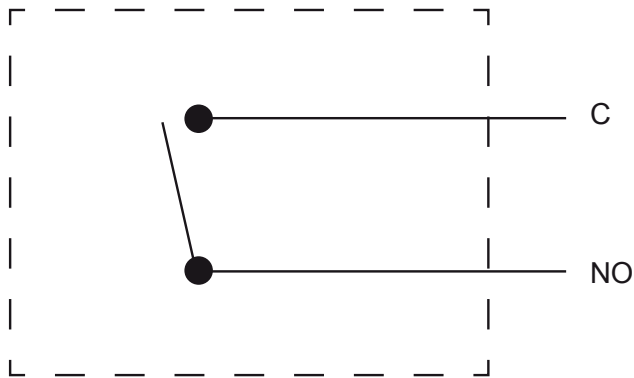

MS911/CW2

Contact 3 fils / 3 wires / 3-adrig / 3 draden

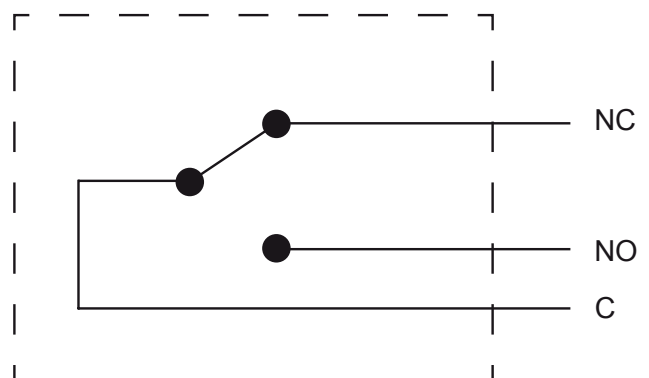

MS911/ALW2

Contact 4 fils / 4 wires / 4-adrig / 4 draden

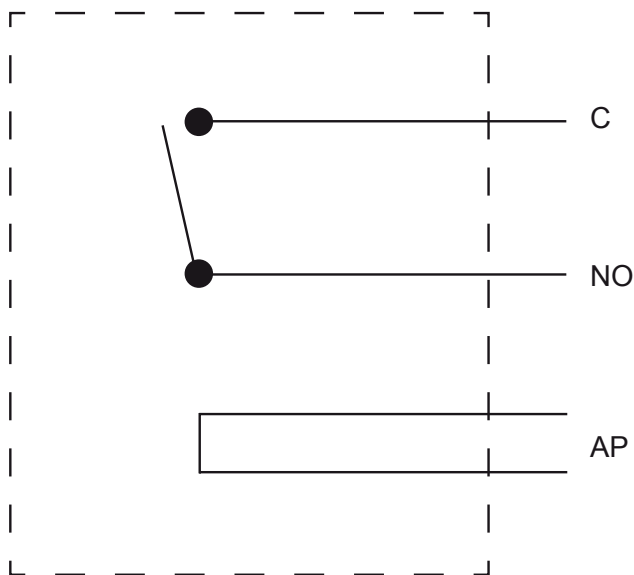

MS911/CLW2

Contact 5 fils / 5 wires / 5-adrig / 5 draden

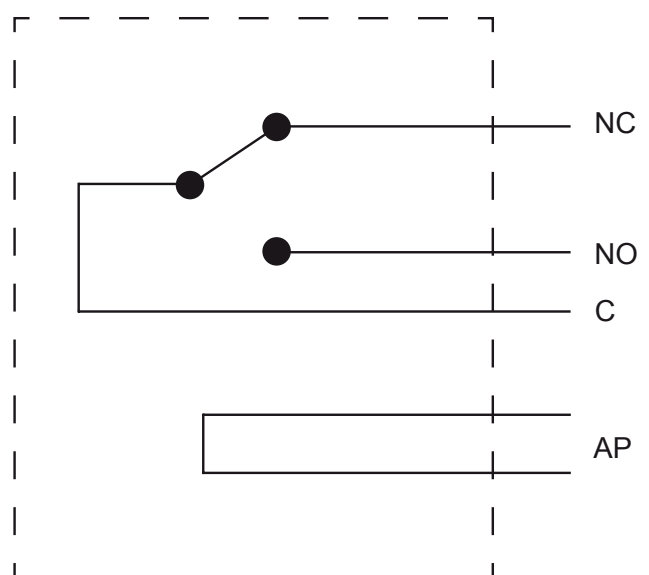

COULEUR DES FILS :
Veuillez vous reporter aux indications figurant sur l'emballage du produit.

KABEL FARBEN:
Bitte Kabel Farben auf der Produkt Verpackung entnehmen.

COLOUR OF THE WIRES :
Please refer to information labelled on product's package.

KLEUR VAN DE KABELS :
Gelieve u uit te stellen tot de aanwijzingen die op de verpakking van het product voorkomen.