



# WIPC-303W

## Gebruikershandleiding

Home View WiFi Camera

Indoor IP Kamera Schwenk-/ Neigefunktion

Caméra IP intérieure motorisée

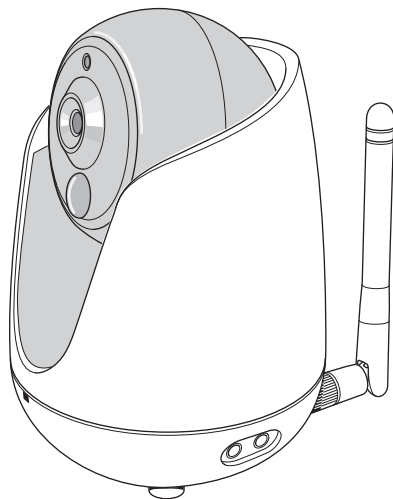

An ASSA ABLOY Group brand

ASSA ABLOY

The smarter way to protect your home.



Not included  
MAX 32GB  
MicroSD

Niet inbegrepen  
Not included  
Nicht enthalten  
Non inclusa



Reset  
Reset  
Zurücksetzen  
Réinitialiser



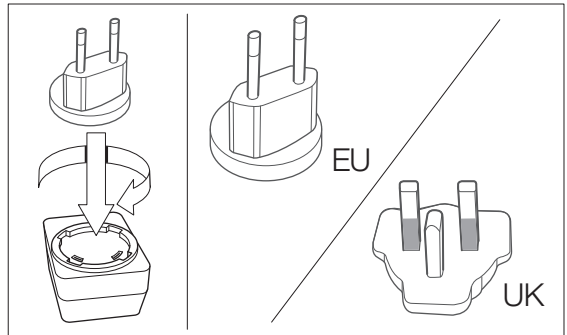
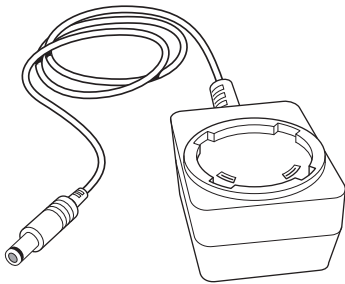
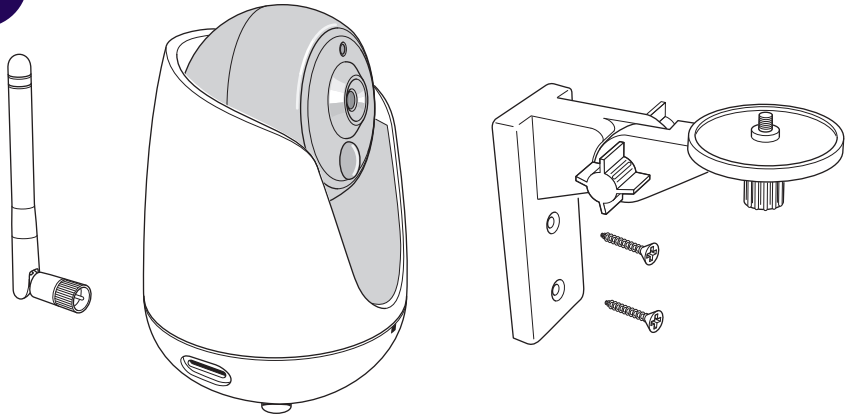



1

Yale Home View 

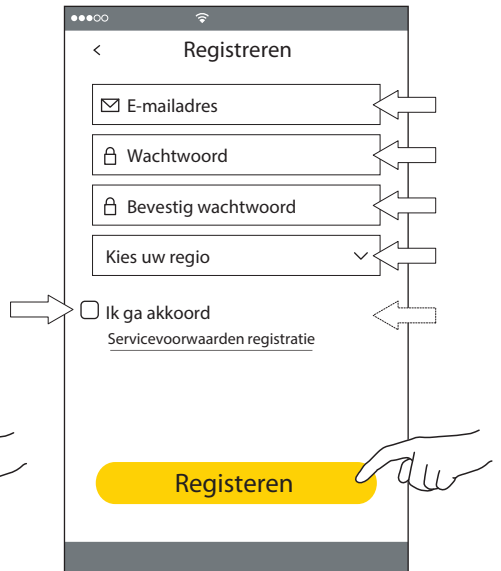
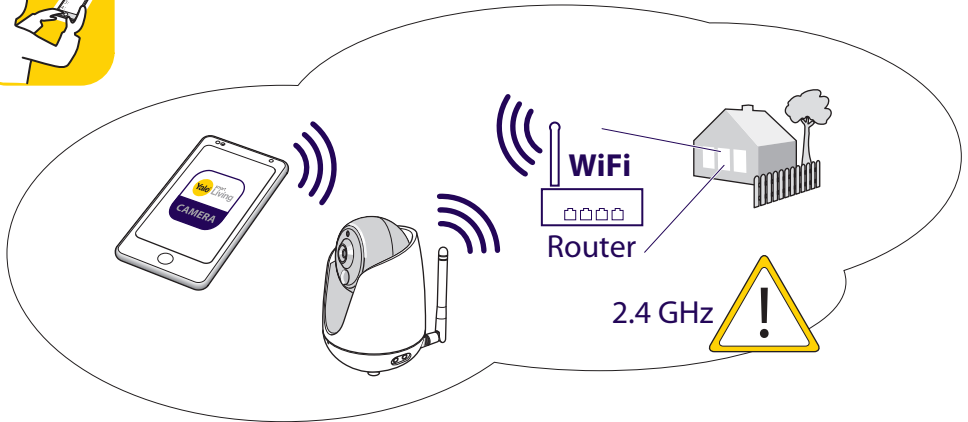

## 2 Account aanmaken



3

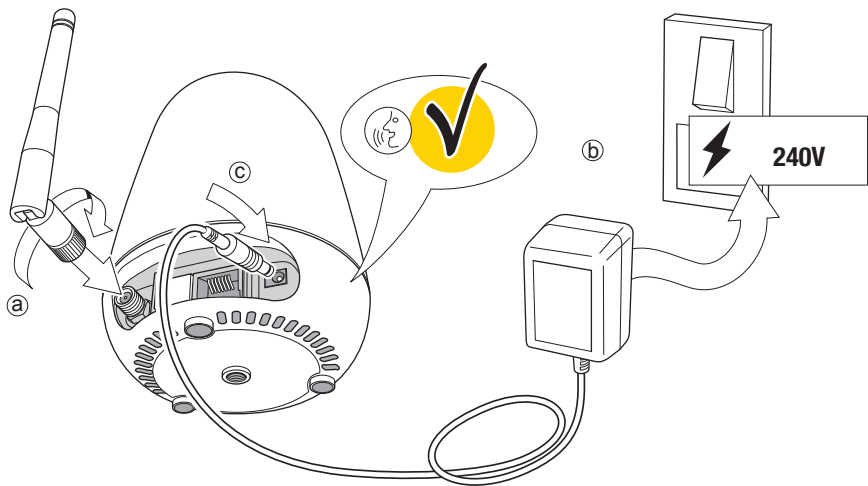

4

### App - Camera instellen



1



2

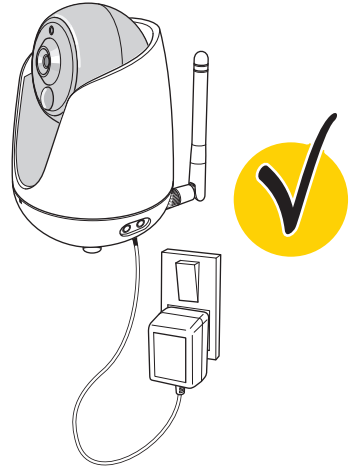
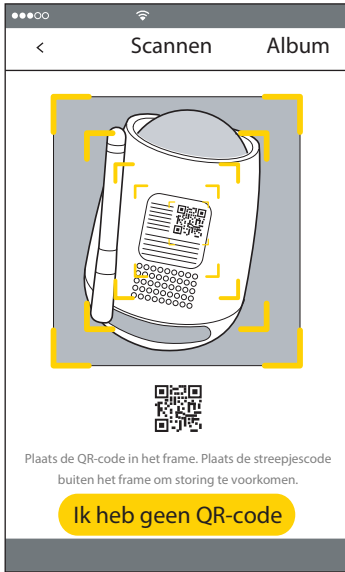

3

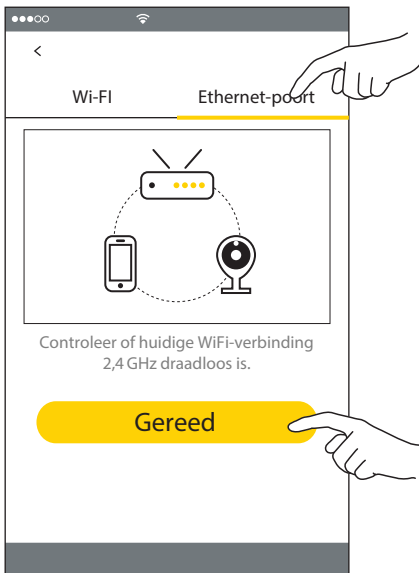

4



5

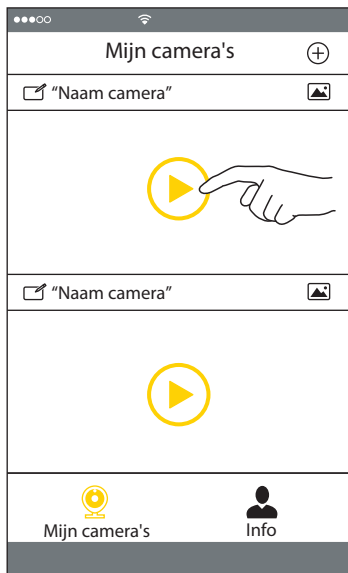

6



7

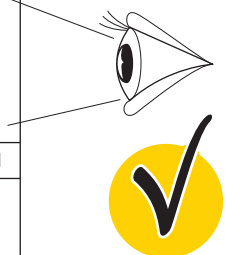
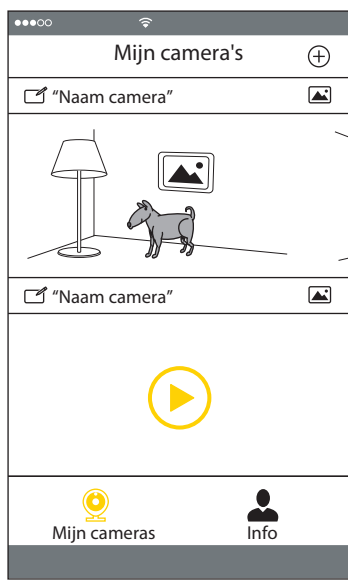

i

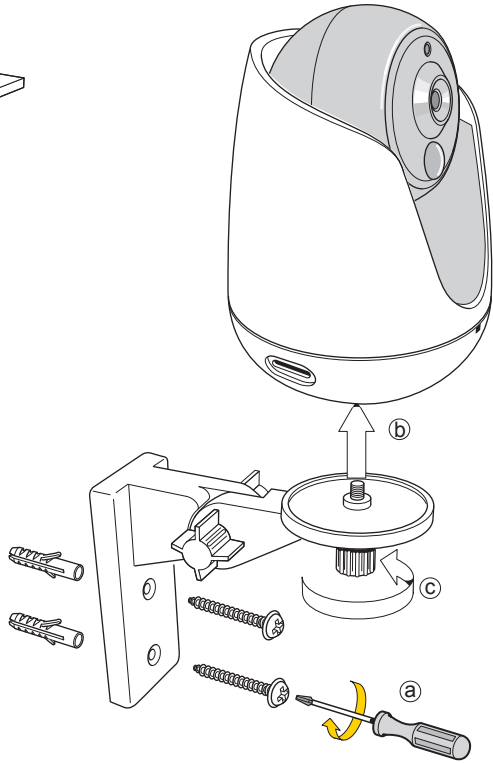
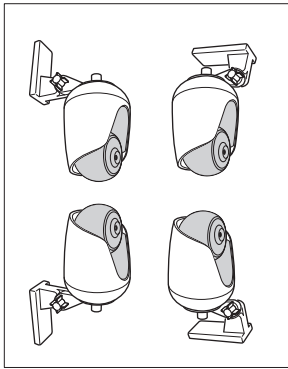
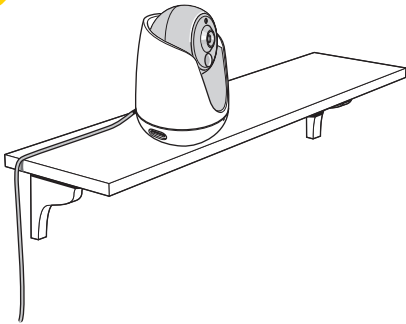

i

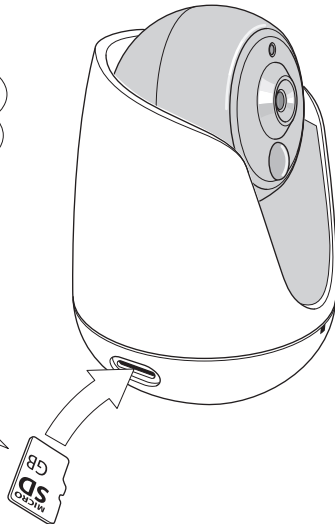
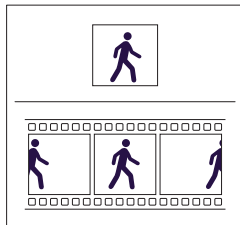
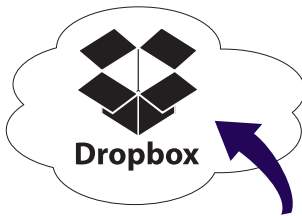





Video

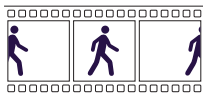

Foto

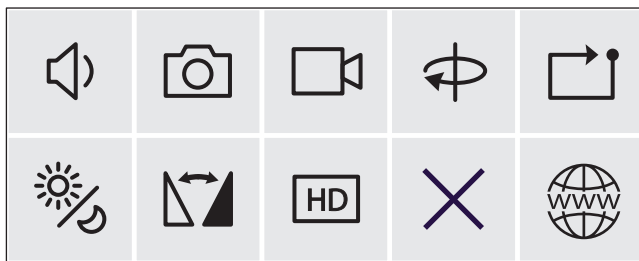
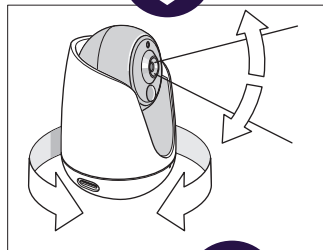

[www.yalelock.nl/smartliving](http://www.yalelock.nl/smartliving)



Aan / Uit / Auto

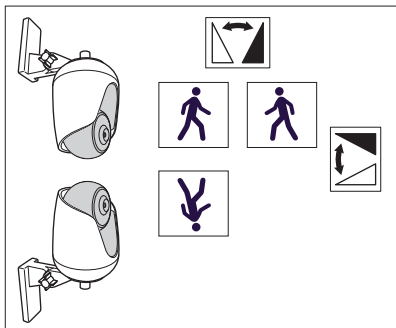

i

**NL:**

Hierbij verklaard, ASSA ABLOY Ltd, School Street, Willenhall, West Midlands, Engeland Wv13 3PW dat de radioapparatuur type WIPC-301W conformeert aan de richtlijn 2014/53/EU. De volledige tekst van de EU Declaratie van Conformiteit is beschikbaar op het volgende internetadres: [www.yalelock.nl/doc](http://www.yalelock.nl/doc)

**GB:**

Hereby, ASSA ABLOY Ltd., School Street, Willenhall, West Midlands, England Wv13 3PW declares that the radio equipment type WIPC-303W is in compliance with Directive 2014/53/EU. The full text of the EU declaration of conformity is available at the following internet address: [www.yalelock.com/smart-living/doc](http://www.yalelock.com/smart-living/doc)

**FR:**

Le soussigné, ASSA ABLOY Ltd., School Street, Willenhall, West Midlands, England Wv13 3PW, déclare que l'équipement radioélectrique du type WIPC-303W est conforme à la directive 2014/53/UE. Le texte complet de la déclaration UE de conformité est disponible à l'adresse internet suivante: [www.yalelock.com/smart-living/doc](http://www.yalelock.com/smart-living/doc)

**... Message à destination des professionnels ...**

*Si vous souhaitez installer WIPC-303W dans votre société, vous devez obligatoirement demander une autorisation à la Commission Nationale de l'Informatique et des Libertés.*

**DE:**

Hiermit erklärt ASSA ABLOY Ltd., School Street, Willenhall, West Midlands, England Wv13 3PW, dass der Funkanlagentyp WIPC-303W der Richtlinie 2014/53/EU entspricht. Der vollständige Text der EU-Konformitätserklärung ist unter der folgenden Internetadresse verfügbar: [www.yalelock.com/smart-living/doc](http://www.yalelock.com/smart-living/doc)

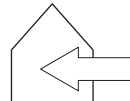
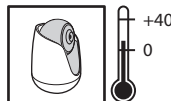
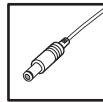



## **i** Ondersteuning



tel nr 0900-4600470  
[www.yalelock.nl/smartliving](http://www.yalelock.nl/smartliving)

**i**

[www.yalelock.nl/smartliving](http://www.yalelock.nl/smartliving)

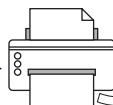

**THE YALE BRAND**, with its unparalleled global reach and range of products, reassures more people in more countries than any other consumer locking solution.

**THE ASSA ABLOY GROUP** is the world's leading manufacturer and supplier of locking solutions, dedicated to satisfying end-user needs for security, safety and convenience.

An ASSAABLOY Group brand

**ASSA ABLOY**